

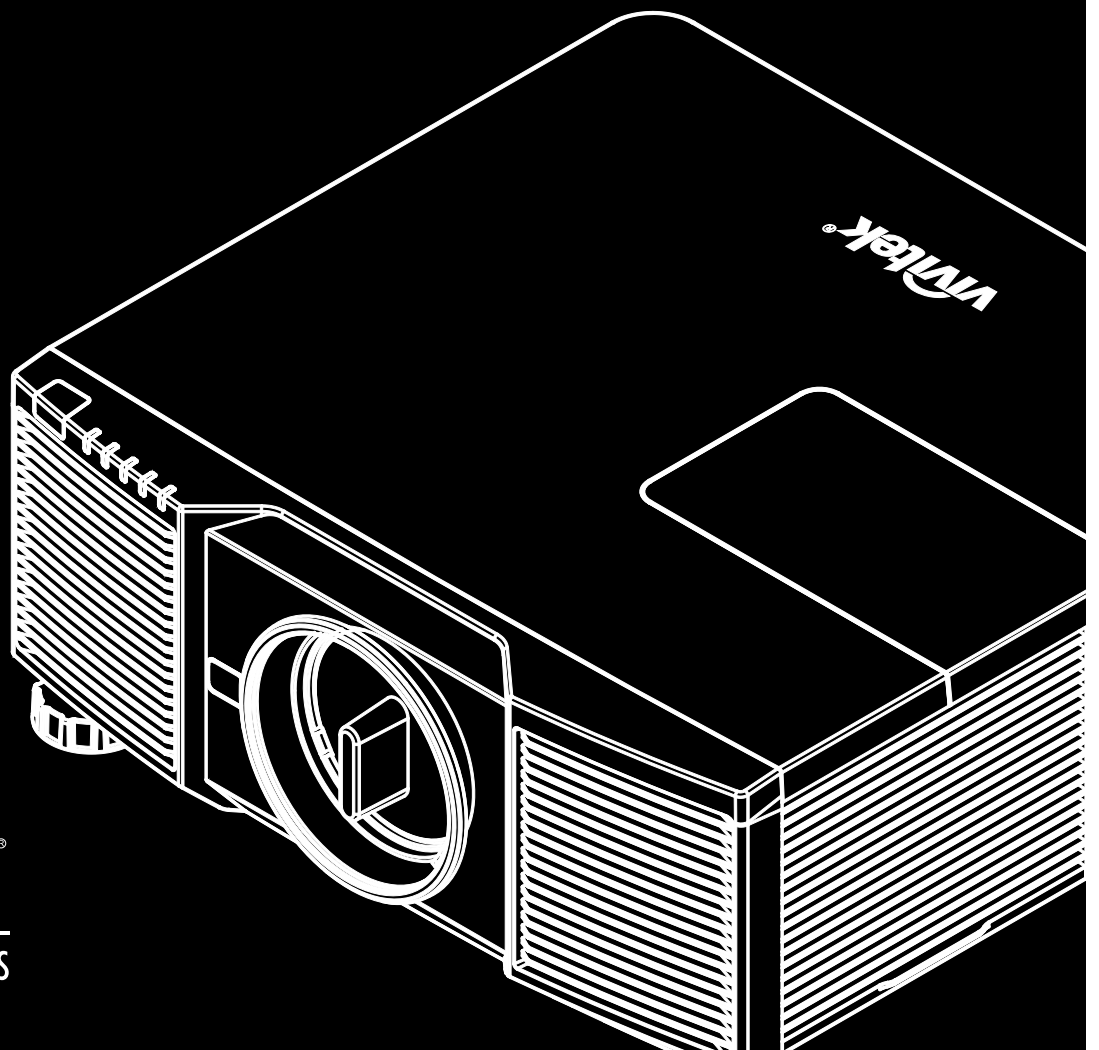

# Remote Communicaton Manual

## DU6771



## Table of Contents

<b>The Serial Interface RS-232 Command .....</b>	<b>2</b>
Communication parameter.....	2
Operation commands.....	2
Operation command syntax .....	2
List of operation commands.....	3
Simulated IR remote controller commands.....	13
List of simulated IR remote controller commands.....	13
<b>Control the Projector Through a Network.....</b>	<b>14</b>
Cable connection .....	14
Set up the projector for networking.....	15
Control the projector through a network .....	16
Control the projector through a web browser .....	16
Control projector with TCP/IP communication protocol .....	19
<b>About Vivitek Support .....</b>	<b>20</b>

## The Serial Interface RS-232 Command

This projector supports to control by RS-232 command, there exists two types of RS-232 serial commands:

- Operation command: The commands are listed by the OSD menus structure as PICTURE, SIGNAL, SETUP, INSTALLATION, SERVICE and SERVICE.
- Simulated IR remote controller commands: Controls projector via RS-232 command, the commands simulate IR remote controller and its control keys.

### Communication parameter

You can use the serial control command to input commands for projector control or retrieve its operational data through Windows client terminal software, e.g. Hyper Terminal, with ASCII characters. You need to set up the following communication parameters in advance:

Item	Parameter:
Bit per Second	9600, 19200, 38400 bps
Data Bit	8-bit
Parity	None
Stop Bit	1
Flow Control	None
Port	7000



- The terminal software does not return every command input character.
- The transmission performance varies with the length of RS-232 cable, please set the baud rate per the cable length.

## Operation commands

### Operation command syntax

An operation command is prefixed by character "op", followed by control commands and settings separated by space blank [SP], and ended by carriage return pair "CR" and "ASCII hex 0D". Syntax of serial control commands:

**op[SP]<operation command>[SP]<Setting Value>[CR]**

- op** : A constant indicating this is an operation command.
- [SP]** : Indicate one blank space.
- [CR]** : Indicate the command ending carriage return pair "CR" and "ASCII hex 0D".
- Setting value** : Settings of operation command

Types of setup strings	Characters of settings	Description
Query current setup	?	Question mark "?" indicates querying current setup
Setup	= <settings>	Syntax: Symbol "=" suffixed with setup values
Increase the value	+	Some settings are changed in steps. Symbol "+" indicates changing one step up
Decrease the value	-	Some settings are changed in steps. Symbol "-" indicates changing one step down
Execute operation command	None	Certain operation commands execute after input without further setting or regulators.

Examples:

Control items	Input command	Projector return message
Query current brightness	op bright ? [CR]	OP BRIGHT = 101
Set brightness	op bright = 127 [CR]	OP BRIGHT = 127
Set input signal source to HDMI	op input.sel = 0 [CR]	OP INPUT.SEL = 0
Reset projection lens to center position	lens.center	



- When sending the multiple commands, make sure the return message of the last command is received before sending out the next one.

## List of operation commands

## PICTURE

OSD Function	Operation command	Settings/Return Values		Available when
Picture Mode	pic.mode	? = + - -	0 = High Bright 1 = Presentation 2 = Video	<ul style="list-style-type: none"> <li>Projector is turned on.</li> <li>Input signal is detected</li> <li>3D mode is turned off.</li> </ul>
Brightness	Bright	? = + - -	0-200	<ul style="list-style-type: none"> <li>Projector is turned on.</li> <li>Input signal is detected</li> </ul>
Contrast	contrast	? = + - -	0-200	<ul style="list-style-type: none"> <li>Projector is turned on.</li> <li>Input signal is detected</li> </ul>
Saturation	saturat	? = + --	0-200	<ul style="list-style-type: none"> <li>Projector is turned on.</li> <li>Input signal is detected</li> <li>Input signal is YUV.</li> </ul>
Hue	tint	? = + - -	0-200	<ul style="list-style-type: none"> <li>Projector is turned on.</li> <li>Input signal is detected</li> <li>Input signal is YUV.</li> </ul>
Sharpness	sharp	? = + - -	0-31	<ul style="list-style-type: none"> <li>Projector is turned on.</li> <li>Input signal is detected. <input type="checkbox"/></li> </ul>
Noise Reduction	nr	? = + - -	0-15	<ul style="list-style-type: none"> <li>Projector is turned on.</li> <li>Input signal is detected.</li> </ul>
Color Temperature	color.temp	? = =	0 = Native 1 = 5400K 2 = 6500K 3 = 7500K 4 = 9300K	<ul style="list-style-type: none"> <li>Projector is turned on.</li> <li>Input signal is detected</li> <li>3D Mode is turned off.</li> </ul>
Gamma	gamma	? = =	0 = 1.0 1 = 1.8 2 = 2.0 3 = 2.2 4 = 2.35 5 = 2.5 6 = S-Curve	<ul style="list-style-type: none"> <li>Projector is turned on.</li> <li>Input signal is detected.</li> </ul>
Advance/Input Balance /Red Offset	red.offset	? = + - -	0-200	<ul style="list-style-type: none"> <li>Projector is turned on.</li> <li>Input signal is detected.</li> </ul>
Advance/Input Balance /Green Offset	green.offset	? = + - -	0-200	<ul style="list-style-type: none"> <li>Projector is turned on.</li> <li>Input signal is detected.</li> </ul>

Advance/Input Balance /Blue Offset	blue.gain	? = + -	0-200	<ul style="list-style-type: none"> <li>• Projector is turned on.</li> <li>• Input signal is detected.</li> </ul>
Advance/Input Balance /Red Gain	red.gain	? = + -	0-200	<ul style="list-style-type: none"> <li>• Projector is turned on.</li> <li>• Input signal is detected.</li> </ul>
Advance/Input Balance /Green Gain	green.gain	? = + -	0-200	<ul style="list-style-type: none"> <li>• Projector is turned on.</li> <li>• Input signal is detected.</li> </ul>
Advance/Input Balance /Blue Gain	blue.gain	? = + -	0-200	<ul style="list-style-type: none"> <li>• Projector is turned on.</li> <li>• Input signal is detected.</li> </ul>
Advance/ HSG /Red Gain	hsg.r.gain	? = + -	0-200	<ul style="list-style-type: none"> <li>• Projector is turned on.</li> <li>• Input signal is detected.</li> </ul>
Advance/ HSG /Green Gain	hsg.g.gain	? = + -	0-200	<ul style="list-style-type: none"> <li>• Projector is turned on.</li> <li>• Input signal is detected.</li> </ul>
Advance/ HSG /Blue Gain	Hsg.b.gain	? = + -	0-200	<ul style="list-style-type: none"> <li>• Projector is turned on.</li> <li>• Input signal is detected.</li> </ul>
Advance/ HSG /Cyan Gain	hsg.c.gain	? = + -	0-200	<ul style="list-style-type: none"> <li>• Projector is turned on.</li> <li>• Input signal is detected.</li> </ul>
Advance/ HSG/ Magenta Gain	hsg.m.gain	? = + -	0-200	<ul style="list-style-type: none"> <li>• Projector is turned on.</li> <li>• Input signal is detected.</li> </ul>
Advance/ HSG /Yellow Gain	Hsg.y.gain	? = + -	0-200	<ul style="list-style-type: none"> <li>• Projector is turned on.</li> <li>• Input signal is detected.</li> </ul>
Advance/ HSG /Red/Saturation	hsg.r.sat	? = + -	0-200	<ul style="list-style-type: none"> <li>• Projector is turned on.</li> <li>• Input signal is detected.</li> </ul>
Advance/ HSG /Green/Saturation	hsg.g.sat	? = + -	0-200	<ul style="list-style-type: none"> <li>• Projector is turned on.</li> <li>• Input signal is detected.</li> </ul>
Advance/ HSG /Blue/Saturation	Hsg.b.sat	? = + -	0-200	<ul style="list-style-type: none"> <li>• Projector is turned on.</li> <li>• Input signal is detected.</li> </ul>
Advance/ HSG /Cyan/Saturation	hsg.c.sat	? = + -	0-200	<ul style="list-style-type: none"> <li>• Projector is turned on.</li> <li>• Input signal is detected.</li> </ul>
Advance/ HSG /Magenta/Saturation	hsg.m.sat	? = + -	0-200	<ul style="list-style-type: none"> <li>• Projector is turned on.</li> <li>• Input signal is detected.</li> </ul>

OSD Function	Operation command	Settings/Return Values		Note
Advance/ HSG /Yellow/Saturation	Hsg.y.sat	? = + -	0-200	<ul style="list-style-type: none"> <li>• Projector is turned on.</li> <li>• Input signal is detected</li> </ul>
Advance/ HSG /Red/Hue	hsg.r.hue	? = + -	0-200	<ul style="list-style-type: none"> <li>• Projector is turned on.</li> <li>• Input signal is detected</li> </ul>
Advance/ HSG /Green/Hue	hsg.g.hue	? = + -	0-200	<ul style="list-style-type: none"> <li>• Projector is turned on.</li> <li>• Input signal is detected</li> </ul>
Advance/ HSG /Blue/Hue	Hsg.b. hue	? = + -	0-200	<ul style="list-style-type: none"> <li>• Projector is turned on.</li> <li>• Input signal is detected</li> </ul>
Advance/ HSG /Cyan/Hue	hsg.c. hue	? = + -	0-200	<ul style="list-style-type: none"> <li>• Projector is turned on.</li> <li>• Input signal is detected</li> </ul>
Advance/ HSG /Magenta/Hue	hsg.m. hue	? = + -	0-200	<ul style="list-style-type: none"> <li>• Projector is turned on.</li> <li>• Input signal is detected</li> </ul>
Advance/ HSG /Yellow/Hue	Hsg.y. hue	? = + -	0-200	<ul style="list-style-type: none"> <li>• Projector is turned on.</li> <li>• Input signal is detected</li> </ul>
Advance/ HSG White/Red Gain	hsg.wr.gain	? = + -	0-200	<ul style="list-style-type: none"> <li>• Projector is turned on.</li> <li>• Input signal is detected</li> </ul>
Advance/ HSG /White/Green Gain	hsg.wg.gain	? = + -	0-200	<ul style="list-style-type: none"> <li>• Projector is turned on.</li> <li>• Input signal is detected</li> </ul>
Advance/ HSG /White/Blue Gain	Hsg.wb.gain	? = + -	0-200	<ul style="list-style-type: none"> <li>• Projector is turned on.</li> <li>• Input signal is detected</li> </ul>
Advance/ HSG Reset	hsg.reset		(execute)	<ul style="list-style-type: none"> <li>• Projector is turned on.</li> <li>• Input signal is detected</li> </ul>

**SIGNAL**

OSD Function	Operation command	Settings/Return Values		Note
Input Select	input.sel	? =	0 = HDMI I 1 = HDMI II 2 = DVI-D 3 = VGA 4 = Component / BNC 5 = HDBaseT	<ul style="list-style-type: none"> <li>Projector is turned on.</li> </ul>
EDID Mode HDMI I	Edid.mode.hdmi	? =	0 = Default 1 = 1024x768@60 2 = 1280x720@60 3 = 1280x800@60 4 = 1280x1024@60 5 = 1600x1200@60 6 = 1680x1050@60 7 = 1920x1080@60	<ul style="list-style-type: none"> <li>Projector is turned on.</li> <li>Adjustment is for current input source.</li> </ul>
EDID Mode HDMI II	Edid.mode.hdmi2	? =	0 = Default 1 = 1024x768@60 2 = 1280x720@60 3 = 1280x800@60 4 = 1280x1024@60 5 = 1600x1200@60 6 = 1680x1050@60 7 = 1920x1080@60	<ul style="list-style-type: none"> <li>Projector is turned on.</li> <li>Adjustment is for current input source.</li> </ul>
EDID Mode DVI-D	Edid.mode.dvi	? =	0 = Default 1 = 1024x768@60 2 = 1280x720@60 3 = 1280x800@60 4 = 1280x1024@60 5 = 1600x1200@60 6 = 1680x1050@60 7 = 1920x1080@60	<ul style="list-style-type: none"> <li>Projector is turned on.</li> <li>Adjustment is for current input source.</li> </ul>
EDID Mode VGA	Edid.mode.vga	? =	0 = Default 1 = 1024x768@60 2 = 1280x720@60 3 = 1280x800@60 4 = 1280x1024@60 5 = 1600x1200@60 6 = 1680x1050@60 7 = 1920x1080@60	<ul style="list-style-type: none"> <li>Projector is turned on.</li> <li>Adjustment is for current input source.</li> </ul>
EDID Mode HDBaseT	Edid.mode.hdbt	? =	0 = Default 1 = 1024x768@60 2 = 1280x720@60 3 = 1280x800@60 4 = 1280x1024@60 5 = 1600x1200@60 6 = 1680x1050@60 7 = 1920x1080@60	<ul style="list-style-type: none"> <li>Projector is turned on.</li> <li>Adjustment is for current input source.</li> </ul>
Auto Source	auto.src	? =	0 = Off 1 = On	<ul style="list-style-type: none"> <li>Projector is turned on.</li> </ul>

OSD Function	Operation command	Settings/Return Values		Note
Color Space	color.space	? =	0 = Auto 1 = YPbPr (Rec 709) 2 = YcbCr (Rec 601) 3 = RGB-PC (0-255) 4 = RGB-Video (16-	<ul style="list-style-type: none"> <li>• Projector is turned on.</li> <li>• The source is detected.</li> </ul>
Aspect Ratio	aspect	? =	0 = 5:4 1 = 4:3 2 = 16:10 3 = 16:9 4 = 1.88 5 = 2.35 6 = LetterBox 7 = Auto 8 = Native	<ul style="list-style-type: none"> <li>• Projector is turned on.</li> <li>• The source is detected.</li> </ul>
Overscan	zoom	? =	0 = Off 1 = On	<ul style="list-style-type: none"> <li>• Projector is turned on.</li> <li>• The source is detected.</li> </ul>
Background	background	? =	0 = Logo 1 = Black 2 = Blue 3 = Custom	<ul style="list-style-type: none"> <li>• Projector is turned on.</li> </ul>
Test Pattern	pattern	? =	0 = Off 1 = White 2 = Black 3 = Red 4 = Green 5 = Blue 6 = Checkboard 7 = CrossHatch 8 = V Burst 9 = H Burst 10 = Color Bar	<ul style="list-style-type: none"> <li>• Projector is turned on.</li> <li>• 3D model is not enabled.</li> </ul>
VGA Setup/H Total	h.total	? = + -	0-200	<ul style="list-style-type: none"> <li>• Projector is turned on.</li> <li>• The source is detected.</li> <li>• The source is from VGA or Component/BNC Input.</li> </ul>
VGA Setup/H Start	h.pos	? = + -	0-200	<ul style="list-style-type: none"> <li>• Projector is turned on.</li> <li>• The source is detected.</li> <li>• The source is from VGA or Component/BNC Input.</li> </ul>
VGA Setup/H Phase	h.phase	? = + -	0-200	<ul style="list-style-type: none"> <li>• Projector is turned on.</li> <li>• The source is detected.</li> <li>• The source is from VGA or Component/BNC Input.</li> </ul>
VGA Setup/V Start	v.pos	? = + -	0-200	<ul style="list-style-type: none"> <li>• Projector is turned on.</li> <li>• The source is detected.</li> <li>• The source is from VGA or Component/BNC Input.</li> </ul>
Auto Sync	auto.img		(execute)	<ul style="list-style-type: none"> <li>• Projector is turned on.</li> <li>• The source is detected.</li> </ul>



## SETUP

OSD Function	Operation command	Settings/Return Values	Note
Language	lang	? = 0 = English 1 = French 2 = Spanish 3 = German 4 = Portuguese 5 = Chinese Simplified 6 = Chinese Traditional 7 = Japanese 8 = Korean	• Projector is turned on.
Lamp Mode	lamps	? = 0 = Dual 1 = Single 2 = Lamp1 3 = Lamp2	• Projector is turned on.
Lamp Power	lamp.mode	? = 0 = Normal 1 = ECO 2 = Custom Power Level	• Projector is turned on.
Custom Power Level	Lamp.pwr	? = 0 ~ 26	• Projector is turned on. • Lamp Mode is set to Custom Power Level.
Startup Logo	Startup.logo	? = 0 = Off 1 = On	• Projector is turned on. • Projector is not at ECO standby mode.
Dynamic Black	dblack	? = 0 = Off 1 = On	• Projector is turned on. • Projector is at Dual lamp mode.
3D 3D Format	3d.format	= ? 0 = Off 1 = Auto 2 = Side-By-Side (Half) 3 = Top-And-Bottom 4 = Frame Sequential	• Projector is turned on.
3D DLP Link	3d.dlplink	? = 0 = Off 1 = On	• Projector is turned on. • 3D Format is not set to Off or Auto.
3D Eye Swap	3d.swap	? = 0 = Normal 1 = Reverse	• Projector is turned on. • 3D Format is enabled.
3D 3D 24Hz Display	3d.144hz	? = 0 = 96Hz 1 = 144Hz	• Projector is turned on. • 3D Format is enabled. • The option is for 24Hz 3D timing only
3D Sync Reference	3d.syncref	? = 0 = Internal 1 = External	• Projector is turned on. • 3D Format is enabled.
3D sync delay	3d.syncdelay	? = 0 – 100	• Projector is turned on. • 3D Format is enabled.
Trigger	triger1	? = 0 = Off 1 = On	• Projector is turned on.
Filter Message	filter.msg	? = 0 = Off 1 = 100H 2 = 200H 3 = 500H 4 = 1000H	• Projector is turned on.

OSD Function	Operation command	Settings/Return Values	Note
Control Panel Lock	keypad.lock	? = 0 = Off 1 = On	• Projector is turned on.
Security Lock	security.lock	? = Password is composed of four characters, U, D, L and R as cursor. U: Up D: Down L: Left R: Right	• Projector is turned on.
Disable Security Lock	security.unlock	(execute)	• Projector is turned on.
Projector ID Control	control.id	? = 0 = Disable ID Control 1 - 99 = Enable ID control and set Control ID	• Projector is turned on.
Menu Position	osd.menupos	? = 0 = Center 1 = Top Left 2 = Top Right 3 = Bottom Left 4 = Bottom Right	• Projector is turned on.

**INSTALLATION**

OSD Function	Operation command	Settings/Return Values	Note
Projection Mode	Proj.mode	? = 0 = Front 1 = Rear 2 = Ceiling + Front 3 = Ceiling + Rear	• Projector is turned on.
Cooling Condition	cooling.condition	? = 0 = Table 1 = Ceiling 2 = Upward 3 = Downward	• Projector is turned on.
High Altitude	altitude	? = 0=Off 1=On	• Projector is turned on.
Standby Mode	Standby.mode	? = 0 = Network Standby 1 = Eco	• Projector is turned on. • Remote sensor is not set to HDBaseT • RS-232 Channel is not set to HDBaseT
Remote Sensor	ir.enable	= ? 0 = Front / Back 1 = Front 2 = Back 3 = HDBaseT 4 = Off	• Projector is turned on. • Front and rear IR receivers are disabled when the option is set to HDBasT or Off.
Network IP Address	net.ip	? = <string>	• Projector is turned on.

OSD Function	Operation command	Settings/Return Values		Note
Network Subnet Mask	net.subnet	? =	<string>	• Projector is turned on.
Network Gateway	net.gateway	? =	<string>	• Projector is turned on.
Network DNS	net.dns	? =	<string>	• Projector is turned on.
Network DHCP	net.dhcp	? =	0 = Off 1 = On	• Projector is turned on.
Network MAC adress	rj45.mac	? =	<string>	• Projector is turned on.
Lens Setting Lens Lock	Lens.lock	? =	0 = Off 1 = On	• Projector is turned on.
Lens Setting Lens Control	zoom.	+ -	+ => Zoom out - =>Zoom in	• Projector is turned on. • Lens Lock is set to Off (0).
Lens Setting Lens Control	focus	+ -	+ => Near - =>Far	• Projector is turned on. • Lens Lock is set to Off(0).
Lens Setting Lens Control	vert.offset	+ -	+ => UP - => Down	• Projector is turned on. • Lens Lock is set to Off (0).
Lens Setting Lens Control	horiz.offset	+ -	+ => Right - => Left	• Projector is turned on. • Lens Lock is set to Off (0).
Lens Setting Lens Type	lens.type	? =	0 = non-UST 1 = UST lens	• Projector is turned on. • Lens Lock is set to Off (0).
Lens Setting Center Lens	lens.center		(execute)	• Projector is turned on. • Lens Lock is set to Off (0).
Lens Setting Load memory setting	lens.load	=	0 to 7 Memory 1 to 8	• Projector is turned on. • Lens Lock is set to Off (0). • Any memory set has been stored in the projector.
Lens Setting Save memory setting	lens.save	=	0 to 7 Memory 1 to 8	• Projector is turned on. • Lens Lock is set to Off (0).
Lens Setting Clear memory setting	lens.clear	=	0 to 7 Memory 1 to 8	• Projector is turned on. • Lens Lock is set to Off (0). • Any memory set has been stored in the projector.
Keystone Horizontal	h.keystone	? =	-30 to 30	• Projector is turned on. • Adjusting Keystone will reset the settings of Corner Adjustment.
Keystone Vertical	v.keystone	? =	-30 to 30	• Projector is turned on. • Adjusting Keystone will reset the settings of Corner Adjustment.
Keystone Reset	keystone.reset		(execute)	• Projector is turned on.
Corner Adjustment Horizontal direction of upper left corner	4corner.ulx	? =	0 to 60	• Projector is turned on. • Adjusting Corner Adjustment will reset the settings of. Keystone.

OSD Function	Operation command	Settings/Return Values	Note
Corner Adjustment Vertical direction of upper left corner	4corner.uly	? 0 to 60 =	<ul style="list-style-type: none"> <li>• Projector is turned on.</li> <li>• Adjusting Corner Adjustment will reset the settings of. Keystone.</li> </ul>
Corner Adjustment Horizontal direction of upper right corner	4corner.urx	? 0 to 60 =	<ul style="list-style-type: none"> <li>• Projector is turned on.</li> <li>• Adjusting Corner Adjustment will reset the settings of. Keystone.</li> </ul>
Corner Adjustment Vertical direction of upper right corner	4corner.ury	? 0 to 60 =	<ul style="list-style-type: none"> <li>• Projector is turned on.</li> <li>• Adjusting Corner Adjustment will reset the settings of. Keystone.</li> </ul>
Corner Adjustment Horizontal direction of lower left corner	4corner.llx	? 0 to 60 =	<ul style="list-style-type: none"> <li>• Projector is turned on.</li> <li>• Adjusting Corner Adjustment will reset the settings of. Keystone.</li> </ul>
Corner Adjustment Vertical direction of lower left corner	4corner.lly	? 0 to 60 =	<ul style="list-style-type: none"> <li>• Projector is turned on.</li> <li>• Adjusting Corner Adjustment will reset the settings of. Keystone.</li> </ul>
Corner Adjustment Horizontal direction of lower right corner	4corner.lrx	? 0 to 60 =	<ul style="list-style-type: none"> <li>• Projector is turned on.</li> <li>• Adjusting Corner Adjustment will reset the settings of. Keystone.</li> </ul>
Corner Adjustment Vertical direction of lower right corner	4corner.lry	? 0 to 60 =	<ul style="list-style-type: none"> <li>• Projector is turned on.</li> <li>• Adjusting Corner Adjustment will reset the settings of. Keystone.</li> </ul>
Corner Adjustment Reset	4corner.reset	? (execute) =	<ul style="list-style-type: none"> <li>• Projector is turned on.</li> </ul>
RS-232 Baud Rate	rs232.speed	? 0 = 38400 = 1 = 19200 2 = 9600	<ul style="list-style-type: none"> <li>• Projector is turned on.</li> </ul>
RS-232 Channel	rs232.channel	? 0 = Local = 1 = HDBaseT	<ul style="list-style-type: none"> <li>• Projector is turned on.</li> </ul>
Auto Power Off	auto.powoff	? = 0 = Off 1 = On	<ul style="list-style-type: none"> <li>• Projector is turned on.</li> </ul>
Auto Power On	auto.powon	? 0 = Off = 1 = On	<ul style="list-style-type: none"> <li>• Projector is turned on.</li> </ul>
Message Box	osd.msgbox	? 0 = Off = 1 = On	<ul style="list-style-type: none"> <li>• Projector is turned on.</li> </ul>
Screen Format	screen.format	? 0 = 16:10 = 1 = 16:9 2 = 4:3	<ul style="list-style-type: none"> <li>• Projector is turned on.</li> </ul>
Screen Fit	screen.shift	? Adjustable range if screen = format is set to 16:10 : 0 16:9 : -60 ~ 60 4:3 : -160 ~160	<ul style="list-style-type: none"> <li>• Projector is turned on.</li> </ul>
Anti-Dust Shutter	Anti.dust.shutter	? 0 = Off = 1 = On	<ul style="list-style-type: none"> <li>• Projector is turned on.</li> </ul>

**SERVICE**

OSD Function	Operation command	Settings/Return Values	Note
Model	model	? <String>	<ul style="list-style-type: none"> <li>• Projector is turned on.</li> </ul>
Serial Number	ser.no	? <String>	<ul style="list-style-type: none"> <li>• Projector is turned on.</li> </ul>

OSD Function	Operation command	Settings/Return Values		Note
Software Version	sw.ver	?	<String>	• Projector is turned on.
Lamp Status Lamp 1	lamp1.stat	?	0=Off 1=On	• Projector is turned on.
Lamp Status Lamp 2	lamp2.stat	?	0=Off 1=On	• Projector is turned on.
Signal Information Signal Format	signal	?	<String>	• Projector is turned on.
Signal Information H/V Refresh Rate	h.refresh v.refresh	?	<String>	• Projector is turned on.
Signal Information Pixel Clock	pixel.clock	?	<number>	• Projector is turned on.
Usage Time Lamp1 / 2 time	Lamp1.hours Lamp2.hours	?	<number>	• Projector is turned on.
Filter Hours	Filter.hours	?	<string>	• Projector is turned on.
Power On Time	Proj.runtime	?	<number>	• Projector is turned on.
Factory Reset	factory.reset		(execute)	• Projector is turned on.

#### Others

Function	Operation command	Settings/Return Values		Note
Power On	power.on		(execute)	• Projector is set to Network Standby
Power Off	power.off		(execute)	• Projector is turned on.
Projector Status	status	?	0 = Standby 1 = Warm Up 2 = Imaging 3 = Cooling	Projector is turned on or set to Network Standby
Blank/Shutter	shutter	+	+ => Close the shutter	• Projector is turned on.
		-	- =>Open the shutter	
Freeze	freeze		0 = Unfreeze 1 = Freeze	• Projector is turned on. • The source is detected
Error Detection	errcode	?	<string>	• Projector is turned on.

Note: The projector returns string "NA" when the input command does not apply to current projector status or setup.

## Simulated IR remote controller commands

This control command simulates the IR remote controller and its control keys. It shares the same syntax of operation command. It begins with characters "ky", followed by control commands and settings separated by space blank [SP], and ended by carriage return pair "CR" and "ASCII hex 0D". Control command syntax:

**ky[SP]<operation command>[CR]**

Examples:

Power On                ky power.on [CR]  
Power Off                ky power.off [CR]

## List of simulated IR remote controller commands

Item	Function	Operation command	Description
1	Power On	power.on	Power On
2	Power Off	power.off	Power Off
3	Menu	menu	Display OSD menu
4	Exit	exit	Exit
5	Enter	enter	ENTER key
6	Up	up	Move cursor upward or change upward
7	Down	down	Move cursor downward or change downward
8	Left	left	Move cursor to the left or change to the left
9	Right	right	Move cursor to the right or change to the right

## Control the Projector Through a Network

This projector supports the following methods in remotely controlling the projector through a network:

- Control projector through web browser.
- Control projector with RS-232 control or simulated IR commands via TCP/IP communication protocol.

### Cable connection

You may connect the projector to a PC by a RJ-45 cable or through a certified HDBaseT transmitter for controlling the projector.

#### Connect the projector to a personal computer

For connection through LAN, connect the hub through to the projector's HDBaseT/LAN port as below illustration.

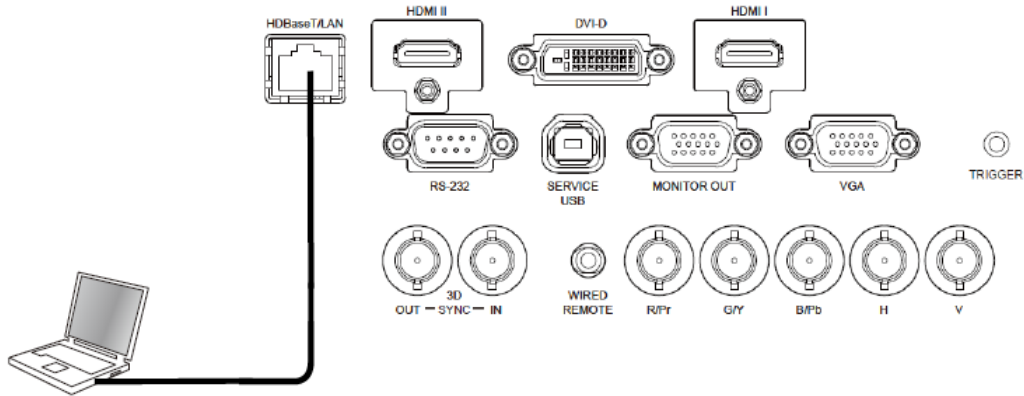

#### Connect with a certified HDBaseT transmitter

You may connect the projector to a certified HDBaseT transmitter to transmit video and networking control signal by one RJ-45 cable. Please connect the PC to the transmitter with one RJ-45 cable or RS-232 cable, then connect HDBaseT transmitter to the HDBaseT/LAN terminal of the projector by one RJ-45 cable, please refer to below illustration.

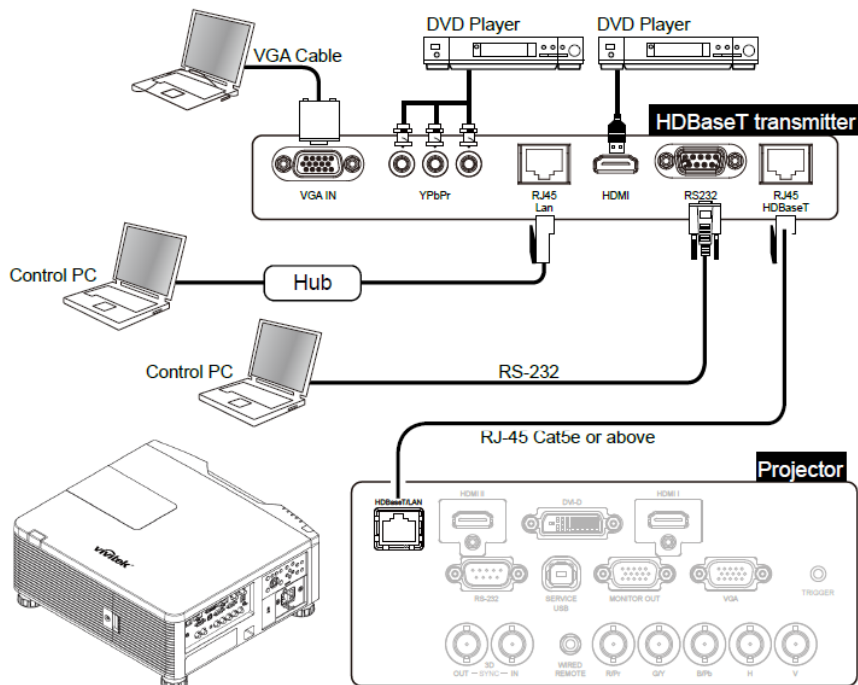

## Set up the projector for networking

Before performing projector control by network, please configure the network setting and make sure Standby Power is set to On.

PICTURE	SIGNAL	SETUP	INSTALLATION	SERVICE
Network				
IP Address				192.168.0.100
Subnet Mask				255.255.255.0
Gateway				192.168.0.1
DNS				192.168.0.1
DHCP				Off
Apply				↔
MAC Address				00:00:00:00:00:00
EXIT = Back		Item Adjust ◀▶		Scroll ▲▼



Network and RS-232 control are disabled if Standby Power is set to off for reducing the standby power consumption (less 0.5W). Please make sure Standby Power is set to On before controlling the projector via RS-232 or LAN.

**IP Address:** Set DHCP “OFF” and specify an IP address manually. Use the ◀▶ button to select the number in the address to change. Use the ▲▼ button to increase or decrease the number in the IP address.

**Subnet Mask:** Set the sub mask. The input method is the same as the setting for IP address.

**Gateway:** Set the gateway. The input method is the same as the setting for IP address.

**DNS:** Set the DNS. The input method is the same as the setting for IP address.

**DHCP:** Enable or disable the DHCP service. When DHCP is set to ON, the DHCP server of the domain will assign an IP address to the projector. The IP address will appear in the IP address window and you don't need to set the IP address. Otherwise, the domain does not or cannot assign any IP address, and 0. 0. 0. 0 is shown on the IP address window.

**Apply:** Confirm the changes on this menu page.

**MAC Address:** Show projector's MAC Address.



## Control the projector through a network

### Control the projector through a web browser

Open the web browser of your control PC; type the projector's IP address. The left of the web page shows below four options:



Projector Status	<table border="1"> <thead> <tr> <th colspan="2" style="background-color: #00AEEF; color: white;">System</th> </tr> </thead> <tbody> <tr><td>Model Name</td><td>DU6771</td></tr> <tr><td>Software Version</td><td>MD13</td></tr> <tr><td>System Status</td><td>Power On</td></tr> <tr><td>Display Source</td><td>HDMI II</td></tr> <tr><td>Lamp 1 Hours</td><td>17</td></tr> <tr><td>Lamp 2 Hours</td><td>10</td></tr> <tr><td>Error Status</td><td>(No Error)</td></tr> <tr> <th colspan="2" style="background-color: #00AEEF; color: white;">RJ45 Version</th> </tr> <tr><td>LAN Version</td><td>RD02</td></tr> <tr><td>IP address</td><td>192.168.0.100</td></tr> <tr><td>Subnet mask</td><td>255.255.255.0</td></tr> <tr><td>Default gateway</td><td>0.0.0.0</td></tr> <tr><td>DNS Server</td><td>0.0.0.0</td></tr> <tr><td>MAC address</td><td>00:18:23:50:F1:BE</td></tr> </tbody> </table>	System		Model Name	DU6771	Software Version	MD13	System Status	Power On	Display Source	HDMI II	Lamp 1 Hours	17	Lamp 2 Hours	10	Error Status	(No Error)	RJ45 Version		LAN Version	RD02	IP address	192.168.0.100	Subnet mask	255.255.255.0	Default gateway	0.0.0.0	DNS Server	0.0.0.0	MAC address	00:18:23:50:F1:BE
System																															
Model Name		DU6771																													
Software Version		MD13																													
System Status		Power On																													
Display Source		HDMI II																													
Lamp 1 Hours		17																													
Lamp 2 Hours		10																													
Error Status		(No Error)																													
RJ45 Version																															
LAN Version		RD02																													
IP address		192.168.0.100																													
Subnet mask		255.255.255.0																													
Default gateway		0.0.0.0																													
DNS Server	0.0.0.0																														
MAC address	00:18:23:50:F1:BE																														
Alert Mail Setup																															
Crestron																															

**Projector Status:** Display current projector status and software information.

**Crestron:** Display Crestron web control page.

**Alert Mail Setup:** Settings for projector abnormality email reminders. In case of any abnormality the project sends emails to preset users.

### Projector Status

This page shows the current status of the projector.

#### System

- Model : Projector model name
- Software Version : The version of the software installed in the projector
- System Status : Current projector startup status
- Display Source : Display the current input source.
- Lamp 1 Hours : Display current Lamp 1 usage.
- Lamp 2 Hours : Display current Lamp 2 usage.
- Error Status : Display current projection mode

#### Network Information (RJ45 version)

- LAN Version Ethernet software version.
- IP address Current IP address setting of the projector
- Subnet mask Current subnet mask setting of the projector
- Default gateway Current default gateway setting of the projector
- DNS server Current DNS server setting of the projector
- MAC address Current MAC address of the projector

**Crestron RoomView**

This page shows Crestron control page for projector control, the available options are as below options.



**Power:** Press this button to turn power on or off.

**Source List:** Switch projector input sources. Press the ▲ or ▼ arrow key to scroll through the dropdown list of available input sources

**Image adjust options**

Press the ◀ or ▶ arrow key to scroll through available adjustment options.

**Freeze:** Freeze current projection screen. The projection screen prompts the "Still open" message after the freeze function enabled. Press the Freeze button again to unfreeze the screen.

**Contrast:** Click this button and the adjustment window displays. Click the ◀▶ arrow keys to adjust contrast.

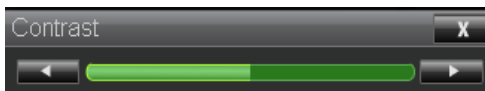

**Brightness:** Click this button and the adjustment window displays. Click the ◀▶ arrow keys to adjust brightness.

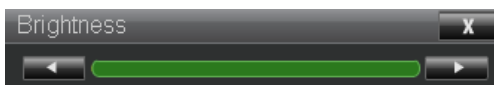

**Sharpness:** Click this button and the adjustment window displays. Click the ◀▶ arrow key to adjust sharpness.

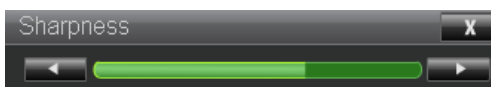

**Zoom:** Zoom the projection image. Click the "+" key to zoom in and "-" to zoom out. You may click the four arrow keys in the window to move the zoomed projection image.

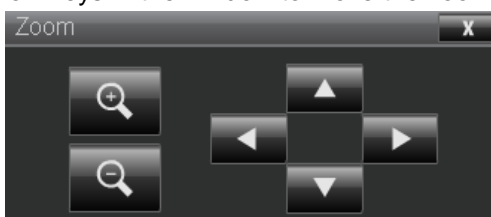

**Control key window**

This window simulates keys on the remote controller and control panel.



**Enter:** Confirm and select function options

**Menu:** Press to display OSD menu. Press again to exit it.

**Auto:** Run the auto image adjustment function.

**Blank:** Pause the image projection, i.e. the projection image is masked. Press again to resume the projection.

**Source:** The signal source menu displays. Press to display signal source in the projection screen.

**Tools:** Check Crestron equipment for its setup

**Info:** Display current projector status and Crestron setup.

**Alert Mail Setup**

This projector can send emails with projector abnormality messages to preset users. Set up the projector before enabling this function:



Projector Status

Alert Mail Setup

Crestron

**SMTP Server:**  **Port:**

**User Name:**

**Password:**

**E-mail Alert:**     Enable     Disable

**From:**

**To:**

**CC:**

**Projector Name:**  x

**Location:**

- SMTP Server : Set up SMTP server name.
- Port : Set up port name.
- User Name : Input user name for the projector to send the reminding message through a SMTP server
- Password : Input password.
- E-mail Alert : Enable or Disable reminding message
- From : Set up sender's email address
- To : Set up receiver's email address
- CC : Set up email address of the email send a copy of a business letter or an e-mail to someone
- Projector Name : Set up projector name or ID.
- Location : Set up projector installation location.
- Apply : Press this button to confirm changes you have made.
- Send Test Mail : Send test email. Press this button to validate email settings after setup is completed.

**Control projector with TCP/IP communication protocol**

This projector supports TCP/IP communication protocol which enables you to send RS-232 operation commands or simulated IR commands to control projectors connected with RJ45 cable via terminal connection application software, e.g. Tera Term. Please set up IP address and port number with the terminal connection application software before controlling your projector with TCP/IP communication protocol:

**IP Address:** IP address of projector

**Port:** Please set transmission port number to 7000

See the section on serial interface RS-232 control commands for details on RS-232 operation commands or simulated IR commands.

## About Vivitek Support

If you cannot find solutions from this user guideline, please contact us using the contact information below:

### North and Central America

#### VIVITEK USA

15700 Don Julian Road, Suite B, City of Industry, CA 91745, U.S.A.

General Enquiries: [marketing@vivitek.com.tw](mailto:marketing@vivitek.com.tw)

Service & Support Enquiries: [T.service1@vivitek.com](mailto:T.service1@vivitek.com).

Telephone: 1-855-VVK-BEST (1-855-885-2378)

### Europe, Middle East and Africa

#### VIVITEK EMEA

Zandsteen 15, 2132 MZ Hoofddorp, The Netherlands

General Enquiries: [support@vivitek.eu](mailto:support@vivitek.eu)

Service & Support Enquiries: [support@vivitek.eu](mailto:support@vivitek.eu)

Tel: +31 20 655 0960

### ASIA

#### VIVITEK ASIA

4F, No. 186, Ruey Kuang Road, Neiho, Taipei 11491, Taiwan R.O.C.

General Enquiries: [marketing@vivitek.com.tw](mailto:marketing@vivitek.com.tw)

Service & Support Enquiries: [gary.hsua@vivitek.com.tw](mailto:gary.hsua@vivitek.com.tw)

Tel: +886 2 8797 2088

### CHINA

#### VIVITEK CHINA

Cimic Plaza, No. 1090 Shiji Boulevard, Pudong Shanghai, 201209, China

General Enquiries: [marketing@vivitek.com.cn](mailto:marketing@vivitek.com.cn)

Service & Support Enquiries: [service@vivitek.com.cn](mailto:service@vivitek.com.cn)

Tel: +86-21-5836-0088

### INDIA

#### VIVITEK INDIA

Plot No. 43, Sector – 35, HSIDC, GURGAON – 122001 (Haryana), India

General Enquiries: [sales@vivitek.in](mailto:sales@vivitek.in)

Service & Support Enquiries: [service@vivitek.in](mailto:service@vivitek.in)

Tel: +91 124-4874900

### TAIWAN

#### VIVITEK TAIWAN

4F, No. 186, Ruey Kuang Road, Neiho, Taipei 11491, Taiwan R.O.C.

General Enquiries: [marketing@vivitek.com.tw](mailto:marketing@vivitek.com.tw)

Service & Support Enquiries: [kenny.kt.chang@vivitek.com.tw](mailto:kenny.kt.chang@vivitek.com.tw)

Tel: +886 2 8797 2088